

Make Your Home a Masterpiece.®



The Studio Series

by AMSCO Windows®





WHY CHOOSE AMSCO WINDOWS STUDIO SERIES?

The Studio Series combines energy efficiency, sturdy design, great looks and features into a solid industry proven performer.

With clean lines, a 3 inch frame, and energy saving CōzE glass standard, this window is ideal for homeowner's who are looking for the perfect mix of performance, appearance and value.

You can choose from a number of options, styles and colors to create the perfect fit.

With over 2 million units installed, this window is an industry leader.

COLORS



The Studio Series, by AMSCO Windows, offers 3 of the most popular colors available in vinyl windows today. White, Almond, and Taupe solid color extrusion both inside and out.



White



STUDIO SERIES COLORS



White

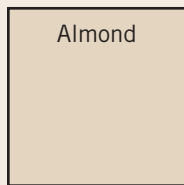

Almond



Taupe



Almond



Taupe



STYLES TO FIT YOUR DESIGN

The Studio Series offers multiple styles for almost any home design. It is available in:

- Single Hung
- Horizontal Slider
- Picture Window
- Speciality Shapes
- Patio Door



Single Hung

- Standard side load single hung.
- Single hung tilt (tilt in sash) for easier cleaning (optional).
- Integral finger pulls on the top and bottom of the sash.
- Block and tackle balance system.
- Equal lite option.

Note: The single hung tilt is not available in the retrofit flush fin application.



Horizontal Slider

- Heavy-duty nylon rollers with a stainless steel axle.
- Integral finger pulls on both sides of the vent.
- Available integral stucco key (nail fin products only).
- Also available in an Equal Lite option.

Patio Door

Available in:

- 2 panel (OX or XO) doors.
- 3 panel (OXO, XXO or OXX) doors.
- 4 panel (OXXO) doors.
- Up to 16 feet wide and 8 feet tall configurations.
- Available in 10 feet wide 2 panel configuration (OX or XO).
- Standard nail fin or optional retrofit flush fin.
- J Channel option.
- Stucco Key option.

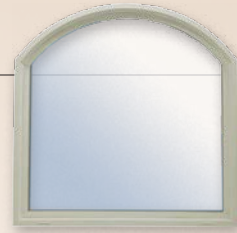

Specialty Shapes

- Round Tops
- Arch Tops
- Octagons
- Full Circles
- Half Circles
- Quarter Circles
- Quarter Angles
- Trapezoids
- Quarter Rectangles
- Eyebrows

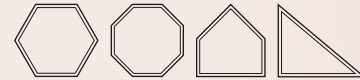

Picture/Fixed Windows

- Direct set, allows for the maximum glass viewing area available.
- These units are available in a retrofit flush fin application.
- Equal site line options.

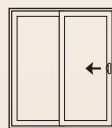

2 PANEL
(OX or XO)

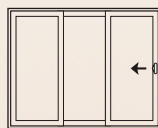

3 PANEL
(OOX or XOO)

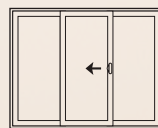

3 PANEL
(OXO)

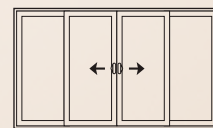

4 PANEL
(OXXO)

FRAME STYLES

The Studio Series is available in a variety of frame styles designed for any possible need from new construction to retrofit/remodeling applications.



1-3/8 Inch Nail Fin Set-Back

Integral 1-3/8 inch nail fin setback, which is the most common frame style for new construction applications.

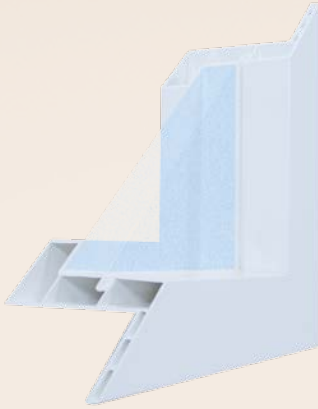

Retrofit-Flush Fin

Integral 1-1/2 inch dual wall retrofit flush fin is located on the exterior of the frame. This frame is also called a jump frame. It allows you to install the window in a retrofit application without removing the old window frame. This method does not damage or interrupt the existing water barrier. It can be used in stucco, brick and siding applications.



1 Inch or 1-3/8 Inch Nail Fin/ Stucco Key

This frame has 1 inch or 1-3/8 inch nail fin setback with a stucco key on the outside of the frame. It is primarily used in one coat stucco applications.



Continuous Frame Option

The continuous frame, or T-Bar, option allows you to join more than one window in a single frame thereby increasing structural integrity.



GRID OPTIONS

The Studio Series allows several grid options to add architectural interest and design elements both inside and out. Grids are available inside of the insulated unit in 5/8 inch flat, 3/4 inch sculptured and 13/16 inch flat grids. Also available in Simulated Divided Lites (SDL's) which are located on the outside of the glass to give the old world look of divided lite windows

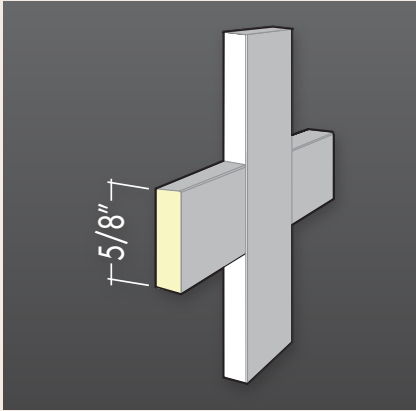

5/8 Inch
Flat Grid

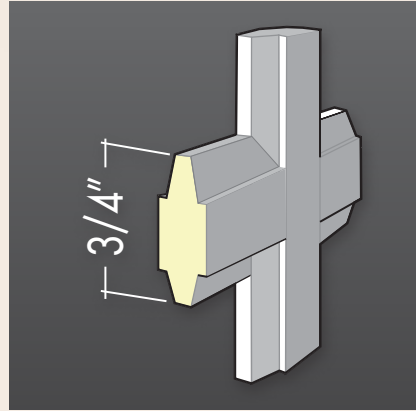

3/4 Inch
Sculptured Grid

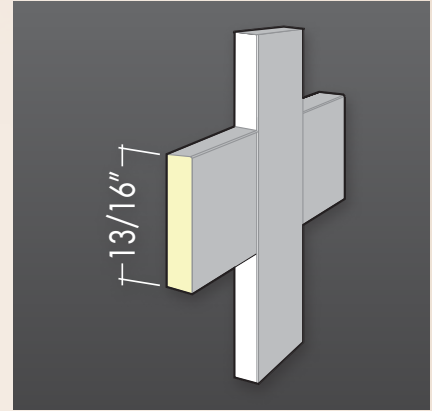

13/16 Inch
Flat Grid

SECURE LOCKING OPTIONS

The Studio Series features the most popular window hardware options with two choices in locks. The classic, time-tested cam-action lock is standard on the Studio Series. For a more contemporary look, choose the sleek, easy-to-use positive action lock, available on all operating windows. Both offer secure locking and peace of mind.



Standard Cam Lock

The standard cam lock is a classic, dependable, long lasting and easy to use option and comes standard on the Studio Series.



Optional Positive Action Lock

The positive action lock is a more contemporary lock, which allows for automatic locking of the window when it is closed.

QUALITY VINYL

Not all vinyl is created equal. Lesser quality vinyl can discolor and warp with exposure to sun and harsh UV light. AMSCO's unique, western-climate specific PVC formula is scientifically formulated to withstand even the harshest conditions season after season – all while maintaining its stability and function, without cracking, chipping, flaking or chalking.



- Will not absorb moisture.
- Color-stabilized vinyl to prevent discoloration.
- Formulated specifically for mountain and southwest climate to maintain stability.
- Protects against damaging effects of UV rays.



Arizona testing facility



Light penetration of competitor's vinyl material

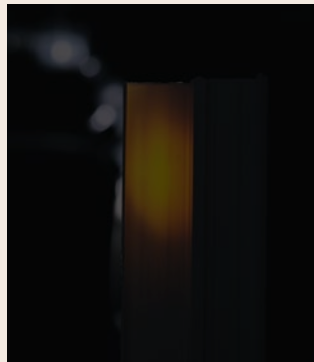

Light penetration of AMSCO's vinyl material

PATENTED VINYL FORMULA

When exposed to identical condition of light intensity, lesser quality vinyl allows more light to pass through. More light means ultraviolet rays can degrade the polymer, leading to deformation and a “dingy” appearance. We add Calcium Carbonate and Titanium Dioxide to boost our patented vinyl formula and deliver superior color retention and stability. So AMSCO windows stay looking like new.

INDEPENDENT DESERT CONDITION TESTS

AMSCO's vinyl is subjected to independent desert condition tests beyond what the industry requires so you can be assured of enjoying your AMSCO windows worry-free for years to come:

- Heat Resistance
- Weatherability
- Air Infiltration
- Water Resistance
- Dimensional Stability
- Impact Resistance
- Weight Tolerance
- Tensile Strength
- Corner-weld Strength

GLASS OPTIONS

High performance, Energy efficient Glass Options protect your home from temperature extremes. All of our glass options feature warm edge spacer technology, which reduces thermal transfer and condensation.

CoZE™

AMSCO CōzE (Standard Low E Glass, Cardinal 270)

Standard on every Studio Series window.

CoZE™ HV

AMSCO CōzE HV (Cardinal 366)

High energy performance rating, high visibility and significant UV protection.

Argon Gas

Can be added to any of our glass configurations to improve energy efficiency.

Brite

Glass designed to be easier to clean and to stay clean longer.

CoZE™ TINT

AMSCO CōzE Tint (Cardinal 240)

High energy performance rating, glare control, and tinted for a beautiful aesthetic appearance.

CoZE™ VANTAGE

AMSCO Vantage Glass

Unique insulated glass unit designed to give you maximum performance in U value and SHGC by utilizing Hard Coat Low E technology. Low E is on two surfaces in this option.

Super Spacer IG units

Closed dense cell material for higher performance.



ADDITIONAL FEATURES

AAMA Gold Labeled

All Studio Series windows and patio doors are tested and certified to structural, water and air infiltration, as well as forced entry. (This is the highest standard in the industry and requires independent auditing for quality assurance)

Clean Appearance

The Studio has clean lines both inside and out with no mull-groove slots to deter the appearance.

Hassle-Free Installation

Engineered for hassle-free installation, giving your installers the flexibility they need.

J Channel

Optional attachable J Channel for siding applications.

CERTIFIED QUALITY

Every AMSCO product meets or exceeds the criteria for a host of critical quality standards.



In addition to our own stringent quality control standards, AMSCO is a proud member of the National Fenestration Rating Council, the American Architectural Manufacturers Association and has earned the right to carry the Energy STAR label, a program sponsored by the Department of Energy. These organizations set the standards for the entire window and door industry.

PERFORMANCE

Below is listed performance data for the Studio Series Window.

	U-VALUE*	SHGC**	VT***	STC****	STRUCTURAL RATING	MAXIMUM SIZE
THE STUDIO SERIES						
SINGLE HUNG	0.34 – 0.29	0.31 – 0.23	0.58 – 0.54	25 – 33	LC-PG25 / LC-PG35 / C-PG50†	48x96 / 48x84 / 44x75
HORIZONTAL SLIDER	0.34 – 0.29	0.31 – 0.23	0.58 – 0.53	25 – 33	R-PG15 / LC-PG25 / LC-PG35	120x72 / 72x72 / 72x60
PICTURE WINDOW (DIRECT SET)	0.32 – 0.26	0.33 – 0.25	0.63 – 0.58	24 – 33	R-PG20 / LC-PG35 / C-PG50†	120x72 / 96x60 / 84x72
EQUAL LITE SINGLE HUNG	0.35 – 0.30	0.29 – 0.22	0.55 – 0.51	25 – 33	LC-PG35	48x84
EQUAL LITE HORIZONTAL SLIDER	0.35 – 0.30	0.29 – 0.22	0.55 – 0.51	25 – 33	LC-PG25	72x72
EQUAL LITE PICTURE WINDOW (SLIDER FRAME)	0.32 – 0.28	0.31 – 0.23	0.58 – 0.53	24 – 33	LC-PG25	72x60

*U-Value represents the amount of heat transfer as measured in accordance with NFRC 100.

**Solar Heat Gain Coefficient (SHGC) measures the amount of solar radiation entering the building as measured per NFRC 200.

***Visible Transmittance (VT) measures the amount of visible light through the overall unit.

NOTE: Data shown is for comparison purposes only and is accurate as of May 1, 2016. Performance data is for overall window units and not glass only. Please contact your Authorized AMSCO Dealer for actual values of units. All values are certified through AAMA and NFRC programs.



ABOUT US

AMSCO Windows is a privately held company founded in 1949. Our 535,000 square foot manufacturing plant is located in Salt Lake City, Utah.

Many of AMSCO's employees have helped to grow the company over decades of service to AMSCO. This stable work environment provides for quality, long-term stability and a company you can count on now and into the future.

AMSCO has an on-site tempering furnace, multiple insulated glass lines and state-of-the-art equipment to assure a consistent and efficient manufacturing process.

AMSCO tempering furnace



THE AMSCO GUARANTEE

Simply put, we back our windows with a warranty that gives you peace of mind. Our Limited Lifetime Warranty covers any defects in materials or workmanship in our vinyl windows and doors for as long as you own your home. Our warranty process is administered by your local dealer to ensure your satisfaction. See your authorized AMSCO dealer or visit us online at www.amscowindows.com for complete warranty details.



MADE IN THE USA



Make Your Home a Masterpiece.®

AMSCO Windows

1880 South 1045 West 801.978.5000 TELEPHONE
PO Box 25368 801.974.0498 FACSIMILE
Salt Lake City, Utah 84125 800.748.4661 TOLL FREE

amscowindows.com



Copyright © 2016 AMSCO Windows. All rights reserved.
Brite, CōzE, Make Your Home a Masterpiece, AMSCO and AMSCO Windows are registered trademarks of AMSCO Windows. ENERGY STAR and the ENERGY STAR mark are registered U.S. marks. All other registered and unregistered trademarks herein are the sole property of their respective owners.